

Behavioral Modeling of Analog Circuits by Wavelet Collocation Method*

Xin Li¹, Xuan Zeng¹, Dian Zhou² and Xieting Ling¹

¹ASIC & System State Key Lab, Microelectronics Dept., Fudan University, Shanghai, 200433, P. R. China

²ECE Dept. University of Texas at Dallas, Richardson, TX 75073, U.S.A.

Abstract

In this paper, we develop a wavelet collocation method with nonlinear companding for behavioral modeling of analog circuits. To construct the behavioral models, the circuit is first partitioned into building blocks and the input-output function of each block is then approximated by wavelets. As the blocks are mathematically represented by sets of simple wavelet basis functions, the computation cost for the behavioral simulation is significantly reduced. The proposed method presents several merits compared with those conventional techniques. First, the algorithm for expanding input-output functions by wavelets is a general-purpose approach, which can be applied in automatically modeling of different analog circuit blocks with different structures. Second, both the small signal effect and the large signal effect are modeled in a unified formulation, which eases the process of modeling and simulation. Third, a nonlinear companding method is developed to control the modeling error distribution. To demonstrate the promising features of the proposed method, a 4th order switched-current filter is employed to build the behavioral model.

1. Introduction

With the remarkable evolution of mixed analog and digital ICs, the need for advanced analog behavioral modeling techniques has become increasingly urgent. First, in top-down designs, the simulation based on behavioral models can provide fast prediction of system performance, which helps to select proper architectures for circuit implementation and analyze tradeoffs at the early design stages [4]. Second, in bottom-up verifications, transistor-level simulation is too expensive in memory space and computation time to afford the verification of a whole mixed-signal chip containing a large number of analog components. Under such circumstance, behavioral models enable designers to verify the complex system efficiently and result in fast system evaluation.

For modeling nonlinear analog circuits, it is required to partition the whole circuit into building blocks and express the input-output relation of each block by a nonlinear function [1]-[5]. After those sophisticated analog circuit blocks are mathematically represented by a set of simple functions, the computational cost for simulation is significantly reduced. There exist two methods to obtain the nonlinear input-output functions: (1) developing the function manually by theoretical analysis [4]; (2) approximating the input-output function by polynomial expansion and determining the unknown coefficients by a set of collocation points [3]. The first approach takes into account the internal non-ideals of the analog circuits and helps designers to understand the physical behavior more accurately and intuitively.

However, such a modeling method is circuit-structure-dependent [4] and can hardly be used in automatic behavioral model generation. Moreover, the manual analysis is time-consuming and too complicated for large circuits. Most importantly, the theoretical models are derived under some assumptions and can work correctly only in a limited input range. For example, Ref. [4] only considers the circuit behavior with small signal input. Therefore, the theoretically derived model in [4] may run in some blind working regions when the input signals are too large. Compared with the theoretical analysis approach, the polynomial approximation is more efficient and flexible. Unfortunately, this approach [3] doesn't consider large signal effect either, and only circuit behaviors with small input signals are characterized. In addition, the issue of modeling error distribution is not addressed in [3]. But in practical applications, designers may require the developed behavioral model to have a constant relative error at different circuit output values. Otherwise, the model may present nonuniform error distribution under different working conditions.

In this paper, we propose a wavelet collocation method to expand the input-output functions of analog circuit blocks by wavelets. Taking advantage of the superior computational properties of wavelets, the proposed method can express both small signal effect and large signal effect by a unified formulation, which eases the process of modeling and simulation. In addition, a nonlinear companding method is developed in this paper to control the modeling error distribution.

The rest of the paper is organized as follows. In Section 2, we introduce the basic principle of the wavelet collocation method for behavioral modeling, then develop the nonlinear companding algorithm for error distribution control in Section 3. To demonstrate the computational efficiency of the proposed method, a 4th order switched-current filter is employed in Section 4 to construct the behavioral model. Finally, we draw conclusions in Section 5.

2. Behavioral Modeling by Wavelets

Without loss of generality, we assume that the input-output relation of an analog circuit block is described by a nonlinear function

$$y = f(x) \quad (1)$$

where y is the output and x represents the input. According to the wavelet approximation theory [6], function $f(\bullet)$ can be expanded by

$$y = \sum_{i=1}^M C_i \cdot W_i(x) \quad (2)$$

where $\{C_i; i=1,2,\dots,M\}$ are unknown coefficients, $\{W_i(x); i=1,2,\dots,M\}$ are wavelet basis functions, and M is the total

* This research is supported by NSFC research project 69806004, NSFC oversea's young scientist joint research project 69928402, foundation for university key teacher by the Ministry of Education, the doctoral program foundation of Ministry of Education of China 2000024628 and National High Technology Research and Development 863 Plan 863-SOC-Y-3-3.

number of basis functions that have been employed. The wavelet basis functions can be constructed by many means [6], but in this paper, we prefer to use the basis functions in [7], [8], because they are proved to have a high convergence rate $O(h^4)$, where h is the step length [7], [8].

Equation (1) can be written in a familiar form after being discretized at some interior collocation points $\{x_1, x_2, \dots, x_N; N \geq M\}$.

$$C \cdot F = Y \quad (3)$$

where

$$C = [C_1 \ C_2 \ \dots \ C_M] \quad (4)$$

$$F = \begin{bmatrix} W_1(x_1) & W_1(x_2) & \dots & W_1(x_N) \\ W_2(x_1) & W_2(x_2) & \dots & W_2(x_N) \\ \vdots & \vdots & \ddots & \vdots \\ W_M(x_1) & W_M(x_2) & \dots & W_M(x_N) \end{bmatrix} \quad (5)$$

$$Y = [y(x_1) \ y(x_2) \ \dots \ y(x_N)] \quad (6)$$

For each value x_i , the value $y(x_i)$ can be found by a transistor-level simulator such as SPICE. Then, the optimal solution for equation (3) with least-square error is given by [9]

$$C = Y \cdot F^T \cdot (F \cdot F^T)^{-1} \quad (7)$$

where T denotes the operation of transpose.

It is worth mentioning that the above wavelet collocation method can be easily extended to multi-input building blocks, as long as the input-output function is expanded by multi-dimension wavelets. For the reason of simplicity, we only discuss the wavelet collocation method for modeling single-input building blocks in this paper.

3. Error Distribution Control by Companding

3.1 Algorithm of Nonlinear Companding

According to wavelet approximation theory [6], the approximation error depends on the singularity of wavelet basis functions. Therefore, the modeling error distribution can be modified if the singularity of wavelet bases is changed. This issue can be realized by a nonlinear companding algorithm proposed in the following.

Assume the input-output function $f(x)$ is defined and modeled in interval $[x_A, x_B]$. We call domain $[x_A, x_B]$ the *Input Domain*. On the other hand, the wavelet basis functions $\{W_i(l); i=1,2,\dots,M\}$ are defined in another domain $[l_A, l_B]$, which is called the *Companding Domain*. The relation between *Input Domain* and the *Companding Domain* is determined by a nonlinear companding function $l = g(x)$. Now, with the nonlinear companding, the original wavelet expansion in equation (2) shall be modified to

$$\begin{aligned} f(x) &= \sum_{i=1}^M C_i \cdot W_i(l) \\ &= \sum_{i=1}^M C_i \cdot W_i[g(x)] \end{aligned} \quad (8)$$

where the wavelet coefficients $\{C_i; i=1,2,\dots,M\}$ can be obtained by the collocation method illustrated in Section 2. The nonlinear function $l = g(x)$ defined in interval $[x_A, x_B]$ shall satisfy the following constraints*.

$$(1) \quad g(x_A) = l_A = x_A \text{ and } g(x_B) = l_B = x_B.$$

$$(2) \quad \text{Function } l = g(x) \text{ is monotonically increasing.}$$

Hence, function $l = g(x)$ establishes a one-to-one mapping between the *Input Domain* and the *Companding Domain*.

3.2 Mechanism of Nonlinear Companding

Equation (8) implies that the process of nonlinear companding is equivalent to transforming a set of wavelet basis functions $\{W_i(l); i=1,2,\dots,M\}$ initially in *Companding Domain* to their counterparts $\{W_i[g(x)]; i=1,2,\dots,M\}$ in *Input Domain*. Then, the companded basis functions $W_i[g(x)]$ are employed to expand the input-output function $f(x)$ in *Input Domain*. The first-order derivative functions of $W_i[g(x)]$ are

$$\frac{dW_i}{dx} = \frac{dW_i}{dl} \cdot \frac{dl}{dx} = \frac{dW_i}{dl} \cdot g'(x); \quad i=1,2,\dots,M \quad (9)$$

Equation (9) demonstrates that the derivative of $W_i(l)$ is scaled by $g'(x)$ after nonlinear mapping. Since the derivative function of a waveform indicates its singularity, equation (9) thus implies that the singularity of the original wavelet basis functions dW_i/dl is changed in *Input Domain*.

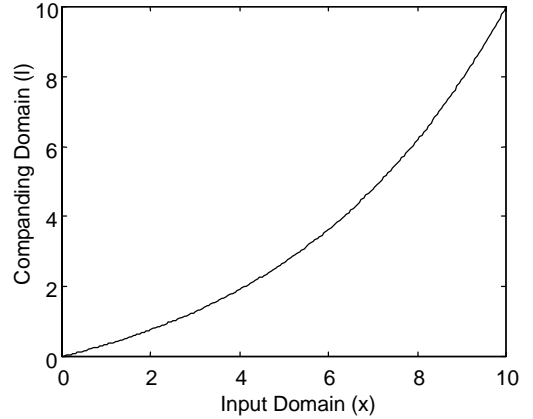

Fig. 1. Nonlinear companding function $l = g(x) = \frac{10}{e^2 - 1} \cdot (e^{0.2x} - 1)$

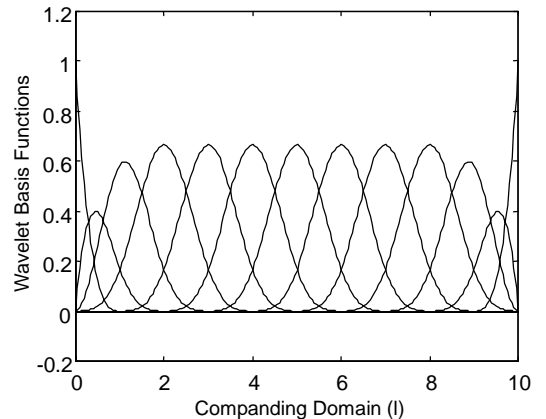

Fig. 2. Wavelet basis functions in *Companding Domain*

For example, consider the nonlinear companding function $l = g(x) = \frac{10}{e^2 - 1} \cdot (e^{0.2x} - 1)$ (displayed in Fig. 1), which is defined in interval $[0, 10]$. Fig. 2 gives the waveforms of a set of wavelet basis

* These two constraints are sufficient, but not necessary, conditions for constructing a companding function. A monotonically decreasing function may also be suitable for nonlinear companding. For simplicity, we only discuss those companding functions satisfying the proposed two constraints, since the similar result can be obtained in other cases.

functions with uniform order in the *Companding Domain*, and their equivalent counterparts in *Input Domain* are depicted in Fig. 3. Comparing Fig. 2 with Fig. 3, one would notice that the companded wavelet basis functions near $x=10$ are much more singular than that near $x=0$. Such a feature can be explained as a result of the nonlinear mapping, because the first-order derivative $g'(x)|_{x=10}$ is greater than 1 and $g'(x)|_{x=0}$ is less than 1. Therefore, when the companded wavelet basis functions are used to represent the input-output function $f(x)$ in *Input Domain*, the singular bases near $x=10$ have the potential to approximate $f(x)$ more accurately since they contain more high frequency components.

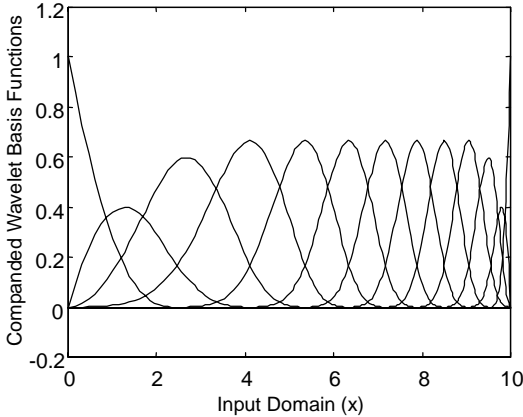

Fig. 3. Companded wavelet basis functions in *Input Domain*

The above analysis indicates that the modeling error in one interval can be reduced by increasing the singularity of wavelet bases in that region. According to equation (9), the singularity of wavelet bases is proportional to $g'(x)$, i.e. the greater the first-order derivative $g'(x)$ is, the more singular the wavelet bases will be. Therefore, we shall increase the value of $g'(x)$ in those regions where high modeling accuracy is required.

Finally, it is important to note that for wavelet approximation, we can modify the modeling error distribution by the nonlinear companding technique because wavelet bases have compact support. However, polynomial basis functions $\{1, x^1, x^2, \dots\}$ have global support so that their error distribution cannot be regulated easily.

3.3 Comparison with the Conventional Wavelet Expansion

According to the multiresolution analysis in conventional wavelet approximation theory, there exists an adaptive scheme which can be used to select proper wavelet basis functions automatically [6]-[8]. The multiresolution analysis decomposes a space H into a set of orthogonal subspaces $\{W_J; J = \dots, -1, 0, 1, \dots\}$, and the approximation accuracy depends upon the wavelet space level J that has been employed. The higher the space level is, the less the error will be. Using adaptive techniques, high-level wavelet bases can only be used in those regions where the input-output function shall be approximated with high accuracy. However, the adaptive algorithm is not so efficient as the nonlinear companding approach in modeling analog circuits. It can be shown [6] that for any multiresolution analysis there exists a wavelet $\Psi(x)$ such that the family of functions

$$\Psi_{J,n}(x) = \sqrt{2^J} \Psi(2^J x - n); \quad J, n = \dots, -1, 0, 1, \dots \quad (10)$$

is an orthogonal basis of W_J at any resolution 2^J . Equation (10) implies that the wavelet bases in W_J can be generated if we compress

those basis functions in lower level space W_{J-1} by one time. In other words, the singularity of the wavelet bases in W_J is doubled, compared with that in W_{J-1} . Note that the singularity of basis functions doesn't change continuously as the wavelet space level J is increased. It, in turn, means that the approximation error doesn't change continuously either, because singularity of wavelet basis functions determines their ability for approximation [6]-[8].

On the other hand, the nonlinear function $l = g(x)$ for companding is continuous and smooth so that it can continuously modify the singularity of the wavelet basis functions, and consequently the modeling error distribution. In many analog-circuit-modeling applications, the absolute modeling error shall be a continuous function of input x , if the input-output function $f(x)$ is continuous and the relative error is required to be constant. Under such circumstances, the nonlinear companding technique is more efficient than the adaptive algorithm, although the latter one is a general-purpose method and is very useful in many other applications.

4. Behavioral Modeling Example

In this section, a 4th order switched-current filter is examined to demonstrate the effectiveness of the proposed wavelet collocation method for analog behavioral modeling.

4.1 Modeling Methodology

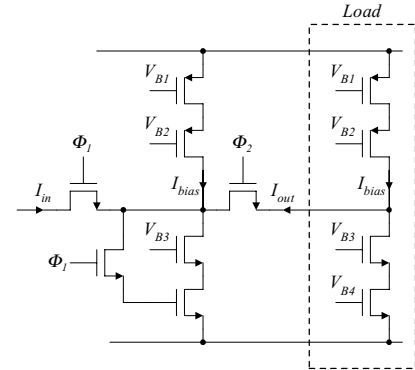

Fig. 4. Switched-current memory cell

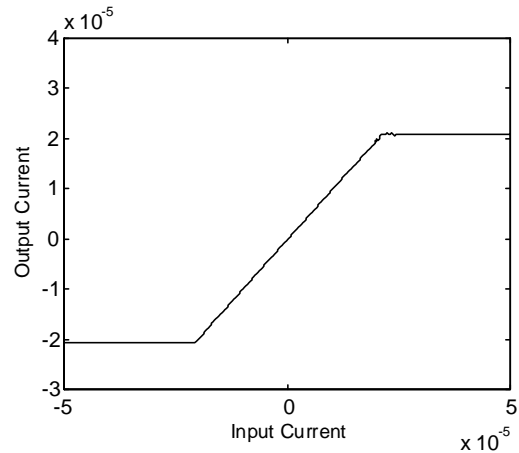

Fig. 5. Input-output function of the switched-current memory cell

Fig. 4 shows the circuit schematic of a second-generation switched-current memory cell, which is the basic building block of switched-current circuits. Combining several basic memory cells, we can realize a 4th-order lowpass Butterworth filter consisting of two biquadratic switched-current filters [10]. For modeling this Butterworth filter, we first represent the input-output function of each building block

by wavelets. Second, we construct the behavioral model of the filter by a signal flow graph, which is derived from the circuit topology and the non-ideal input-output relationship of each block. Such a signal-flow-graph-based model is then simulated by MATLAB SIMULINK to verify the accuracy of the proposed model. In the following, we take the current memory cell as an example to present the block modeling method by wavelets.

Denote $I_{in}\left(n-\frac{1}{2}\right)$ as the input current of the memory cell and $I_{out}(n)$ as its output current. Then, the input-output relation of the memory cell can be modeled in equation (11).

$$I_{out}(n) = \begin{cases} f\left[I_{in}\left(n-\frac{1}{2}\right)\right], & \text{when } \Phi_2 = \text{high} \\ 0, & \text{when } \Phi_2 = \text{low} \end{cases} \quad (11)$$

Function $f(\bullet)$ is weakly nonlinear [3]-[5] for small signal input, where non-ideal factors such as mismatch, charge injection, finite output impedance, etc. are considered. However, for large signal input, $f(\bullet)$ will exhibit strongly nonlinear, because the output current I_{out} is restricted by the bias current $I_{bias} = 20\mu A$ as simulated by SPICE in Fig. 5. In order to cover the effect of large signal input, we approximate the input-output function $f(\bullet)$ in interval $[-50\mu A, 50\mu A]$ when building behavioral models. Furthermore, we require the developed behavioral model to have a constant relative error at different circuit output values. Applying the nonlinear companding technique introduced in Section 3, we can achieve the uniform relative error distribution by the following three steps.

Step 1. *Specify the modeling requirements.* In the current application, the relative simulation error shall be constant. Such a linguistic specification can be mathematically expressed as an explicit merit function

$$Q = \left(Err_R|_{Input=\pm 5\mu A}\right)^2 + \dots + \left(Err_R|_{Input=\pm 50\mu A}\right)^2 \quad (12)$$

The notation $Err_R|_{Input=\pm i\mu A}$ represents the relative simulation error when the switched-current memory cell is simulated with a sinusoidal input of amplitude $\pm i\mu A$ ($i = 5, 10, \dots, 50$). The relative simulation error is defined as

$$Err_R = \sqrt{\frac{\int [y_{SPICE}(t) - y_{Model}(t)]^2 dt}{\int [y_{SPICE}(t)]^2 dt}} \quad (13)$$

where $y_{SPICE}(t)$ is the simulation result by SPICE and $y_{Model}(t)$ is the result by the developed behavioral model. After merit function (12) is minimized, we have $Err_R|_{Input=\pm 5\mu A} = \dots = Err_R|_{Input=\pm 50\mu A}$, so that the minimum and constant relative error is obtained.

Step 2. *Build the prototype of nonlinear companding function $l = g(x)$.* Our goal is to keep the relative simulation error constant. When the input-output function in Fig. 5 is expanded by wavelets, the absolute approximation error near $x = 0\mu A$ shall be smaller than that near $x = \pm 50\mu A$. Recall that we shall increase the value of $g'(x)$ in those regions where high model accuracy is needed. Therefore, the derivative of the companding function $g'(x)|_{x=0}$ shall be greater than $g'(x)|_{x=\pm 50\mu A}$. Define the prototype function in interval $[-5 \times 10^{-5}, 5 \times 10^{-5}]$ as

$$l = g(x) = \frac{5 \times 10^{-5}}{\ln(1 + 5 \times 10^{-5} p)} \cdot \text{sign}(x) \cdot \ln(1 + p|x|) \quad (14)$$

where p is a parameter controlling the nonlinearity of the function

and its value is to be determined by an optimization process in Step 3.

Step 3. *Refine the prototype function.* With merit function (12) and the prototype function (14), we optimize parameter p by the Golden Section Search method [9]. As long as the minimum value of (12) is reached, the optimal p is found and consequently the proper companding function $l = g(x)$ is determined.

4.2 Simulation Results of the Memory Cell

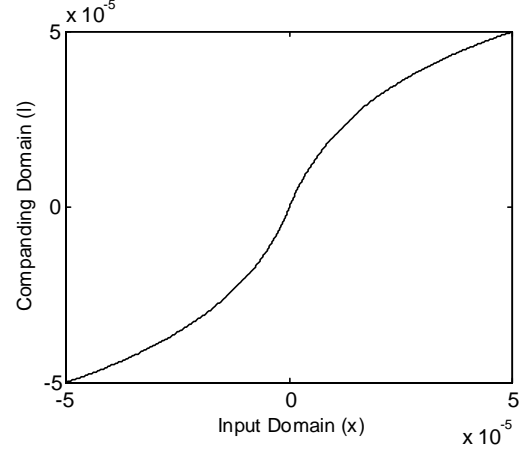

Fig. 6. Optimal nonlinear companding function $l = g(x)$

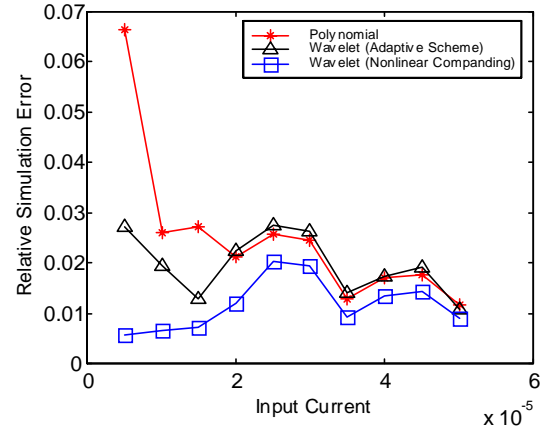

Fig. 7. Relative simulation error of different models

In this section, three methods in all are applied to approximate the input-output function of the switched-current memory cell in interval $[-50\mu A, 50\mu A]$. First, the polynomial expansion is employed to express the input-output function by 15 basis functions. Second, we use the conventional wavelet collocation method with adaptive scheme to automatically employ proper high-level wavelet basis functions in those regions where high accuracy is needed. As a result, 17 wavelet bases are selected by the adaptive scheme to represent the input-output function. Third, the wavelet collocation method with nonlinear companding is applied to approximate the input-output function by 15 basis functions. Fig. 6 depicts the optimal companding function $l = g(x)$ after the merit function (12) is minimized. The behavioral models developed by these three approaches are tested respectively with sinusoidal inputs of different amplitude $\pm i\mu A$ ($i = 5, 10, \dots, 50$). Fig. 7 depicts the relative simulation errors, defined in equation (13), for these three models. Note that the relative error of polynomials increases as the input current amplitude decreases, which demonstrates that the modeling error distribution is completely uncontrolled. On the other hand, the wavelet expansion with either adaptive scheme or nonlinear

companding is able to keep the relative error almost unchanged at any output value. Moreover, it is shown in Fig. 7 that the modeling error of the nonlinear companding technique is less than that of the adaptive scheme, although the wavelet basis functions employed by the latter method are more than those employed by the former approach. In this point of view, the nonlinear companding method is more efficient than the conventional adaptive scheme in modeling switched-current circuits, which consists with the theoretical analysis in Section 3.3.

4.3 Simulation Results of the 4th Order Filter

Using the memory cell model developed above, we simulate the signal-flow-graph-based filter model by MATLAB SIMULINK. In the following, we present the results.

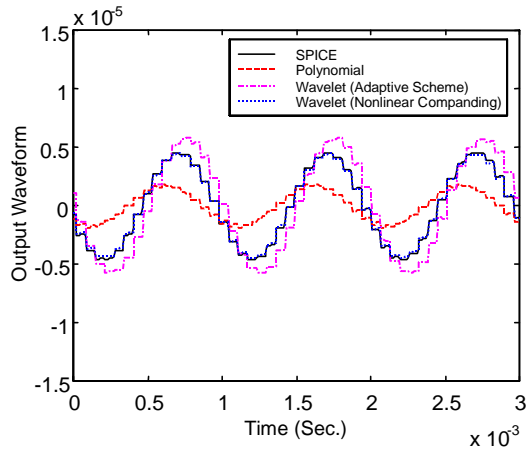

Fig. 8. Time domain response of the 4th order filter

1. *Time domain response.* First, we test the filter models by a sinusoidal input of frequency $1kHz$ and amplitude $\pm 10\mu A$ (small signal input). Fig. 8 gives the time-domain simulation results obtained from SPICE and three kinds of different models. Again, these results indicate that the model developed by the wavelet collocation method with nonlinear companding is the most accurate one in predicting circuit behaviors under small signal input.

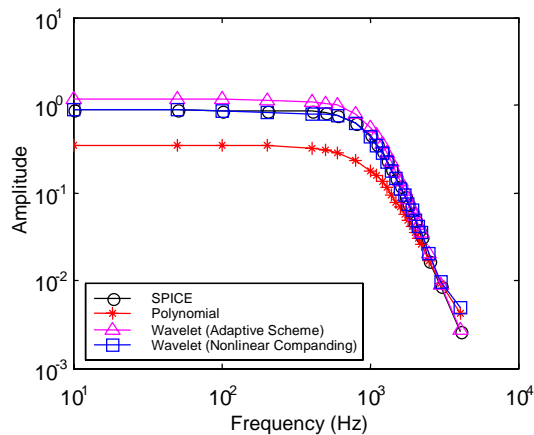

Fig. 9. Frequency domain response of the 4th order filter

2. *Frequency domain response.* Second, the filter model is tested with sinusoidal inputs of amplitude $\pm 10\mu A$ (small signal input) at different frequencies. Fig. 9 depicts the frequency response obtained from SPICE and three kinds of different models. Note that the model expressed by wavelet expansion with nonlinear companding works much better than the other two ones.

3. *Simulation speed.* We run the behavioral simulations on a Pentium III-550 computer. Assume that a transient simulation is performed for

the 4th order switched-current filter in time domain $[0, 5ms]$, then the computation time is 380 seconds by SPICE, 2.0 seconds by the behavioral model with polynomial expansion, 5.0 seconds by the behavioral model with wavelet expansion (adaptive scheme) and 2.8 seconds by the behavioral model with wavelet expansion (nonlinear companding). Compared with SPICE, the overall speed up with behavioral models is about two orders in time domain.

5. Conclusion

We propose in this paper a wavelet collocation method with nonlinear companding for behavioral modeling of analog circuits. The proposed method presents several merits in contrast with those conventional techniques.

First, compared with the modeling approach by theoretical analysis, the proposed method is a general-purpose one. It can be applied in automatically modeling different analog circuit blocks with different structures.

Second, compared with the conventional polynomial expansion, the proposed method can include small signal effect and the large signal effect in a unified formulation with constant relative error distribution. It, in turn, eases the process of both modeling and simulation.

Third, compared with the conventional adaptive wavelet collocation method, the proposed method has the potential to regulate modeling errors continuously. Therefore, it is more efficient than the adaptive scheme in dealing with analog circuit modeling, although the latter method is more general and very useful in many other applications.

In conclusion, as a counterpart of those conventional techniques, the wavelet collocation method with nonlinear companding exploits a new general-purpose approach for modeling analog circuits in behavioral-level simulations.

Reference

- [1] D. Johns and K. Martin, *Analog Integrated Circuit Design*, John Wiley & Sons, New York, 1996.
- [2] H. Chang, E. Charbon et al, *A Top-Down Constraint-Driven Design Methodology for Analog Integrated Circuits*, Kluwer Academic Publishers, Massachusetts, 1997.
- [3] E. Schneider and T. Fiez, "Simulation of switched-current systems," *IEEE International Symposium on Circuits and Systems*, pp. 1420-1423, 1993.
- [4] A. Yúfera and A.Rueda, "Studying the effects of mismatching and clock-feedthrough in switched-current filters using behavioral simulation," *IEEE Trans. Circuits and Systems - II*, vol. 44, pp. 1058-1067, Dec. 1997.
- [5] X. Zeng, W. Wang, J.L.Shi, Y.Liu, P.S.Tang, "Time domain behavioral models of switched-current building block circuits", *Proceedings of Conference on Chip Design Automation, 16th IFIP World Computer Congress*, pp.481-488, Aug. 2000.
- [6] C. K. Chui, *An Introduction to Wavelets*, Academic Press, New York, San Diego, 1992.
- [7] Dian Zhou and Wei Cai, "A fast wavelet collocation method for high-speed circuit simulation," *IEEE Trans. Circuits and Systems - I*, vol. 46, pp. 920-930, Aug. 1999.
- [8] Dian Zhou, Wei Cai and Wu Zhang, "An adaptive wavelet method for nonlinear circuit simulation," *IEEE Trans. Circuits and Systems - I*, vol. 46, pp. 931-938, Aug. 1999.
- [9] W. Press, B. Flannery, S. Teukolsky and W. Vetterling, *Numerical Recipes in C The Art of Scientific Computing*, Cambridge University Press, New York, 1988.
- [10] C. Toumazou, J. Hughes and N. Battersby, *Switched-Currents: An Analogue Technique for Digital Technology*, Peter Peregrinus Ltd., 1993.